

PREMIUM CUSTOM WOOD DOOR

FOREST BRIGHT
ARCHITECTURAL WOOD DOOR

FOREST BRIGHT WOOD INDUSTRY CO., LTD.

+86-0311-89899996

info@forestbright.com

www.forestbright.com

B-501 Building No.1, Changjiu Center, No. 88 Zhujiang Rd., Shi jia zhuang, China

FOREST BRIGHT
ARCHITECTURAL WOOD DOOR

INDEX

ABOUT US 01 - 04

ACME 05 - 18

GRACE 19 - 22

RHYME 23 - 28

SHAKER 29 - 34

HARMONY 35 - 38

MAGIC DOOR 39 - 40

STANDARD VENEER STAINED COLOURS 41 - 42

TECHNICAL DRAWINGS 43 - 44



ABOUT FOREST BRIGHT

Forest Bright Wood Industry Co., Ltd. is one of China's leading manufacturers of premium quality architectural wooden doors. Forest Bright offers a blended product portfolio that delivers interior door products to suit a wide range of specifications.

We widely cooperate with prestigious international hotels and real estate brands in the USA, Europe, and the Middle East. Meanwhile, we closely work with China leading commercial hardware manufacturers to develop a packaged solution of doors and hardware and provide a one-stop purchasing service for our clients.

Forest Bright persistently invests in the production line and quality management, from raw material procurement to packaging, all strictly sticking to international standards.

- All our wood doors meet or exceed WDMA or AWI architectural flush wood door and stile & rail wood door standards.
- Our fire-rated wooden door passed 20 minutes, 45 minutes, 60 minutes, and 90 minutes positive pressure test, meet USA NFPA 252 (2012); UBC 7-2; UL 10C standard.

Sustainable development is our operation purpose. What we love is the beauty of wood; we also treasure our environment. Our cores, stiles, rails, crossbands, laminates, and veneers are available in FSC® certified options. We used water-based paint and no-added-urea-formaldehyde adhesives in keeping with our policy of protecting the environment.

Broad market prospects have resulted from the rapid development of the China building industry and China's enhanced international trade relations. We are optimistic about our ability to win more and more domestic and international cooperation in the future.

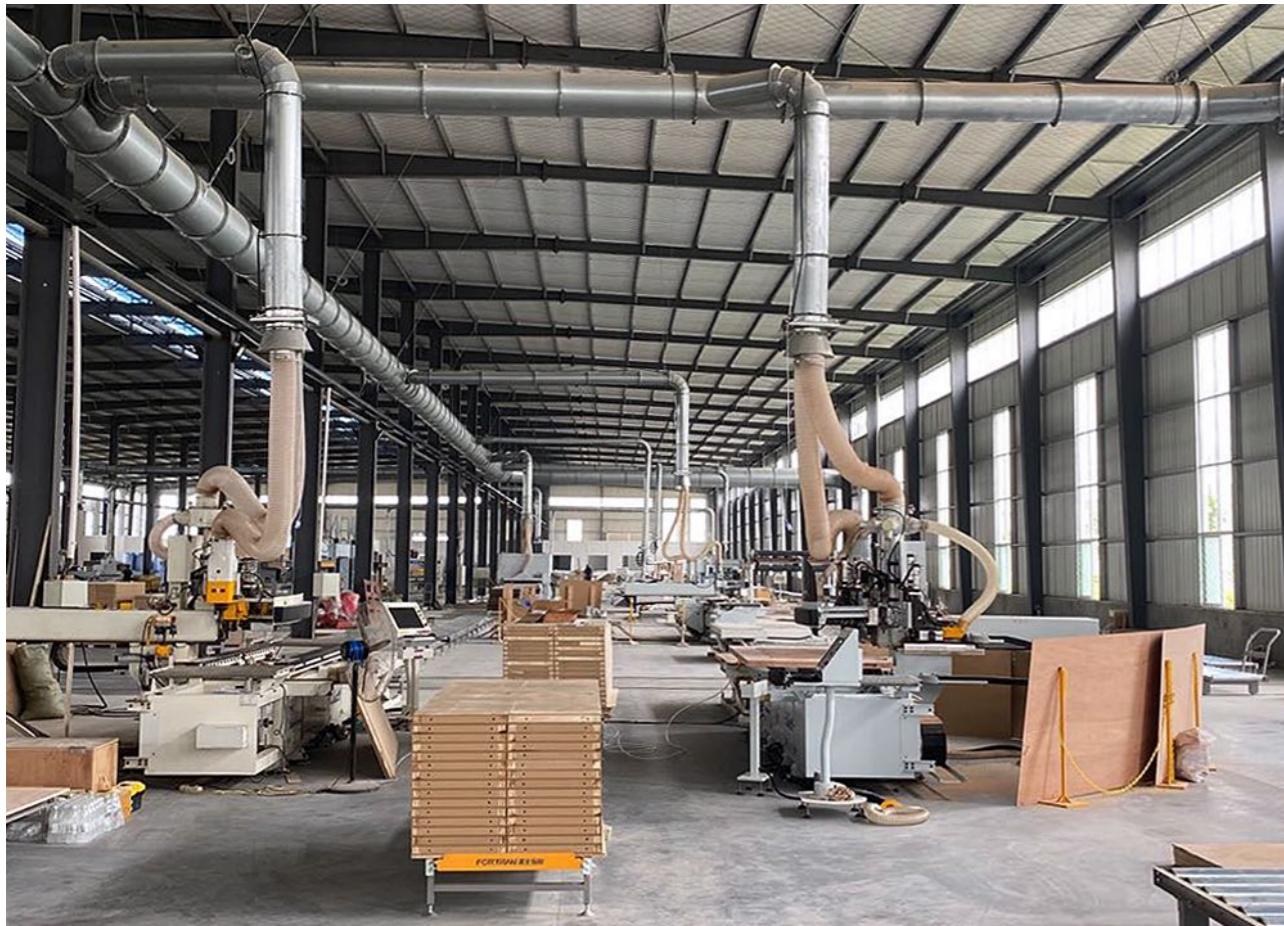

OUR MISSION

- To create truly great doors with a new and unique value and to provide the best customer service.
- Through unique corporate activities, to create value for customers and contribute to staff's happy life.

OUR VALUE

- Focus on creating value for customers.
- Driven by innovation.
- Respecting and supporting individuals to foster both corporate and personal growth.
- Persist in sustainable development.
- Committing to ethical standards and correctness.

OUR PRINCIPLE

- Pursue excellence and value details.
- Achieve strong results through the promotion of diversity and teamwork.
- Move speedily and decisively in everything we do.
- Communicate frankly, think empathy.



ACME



European Oak

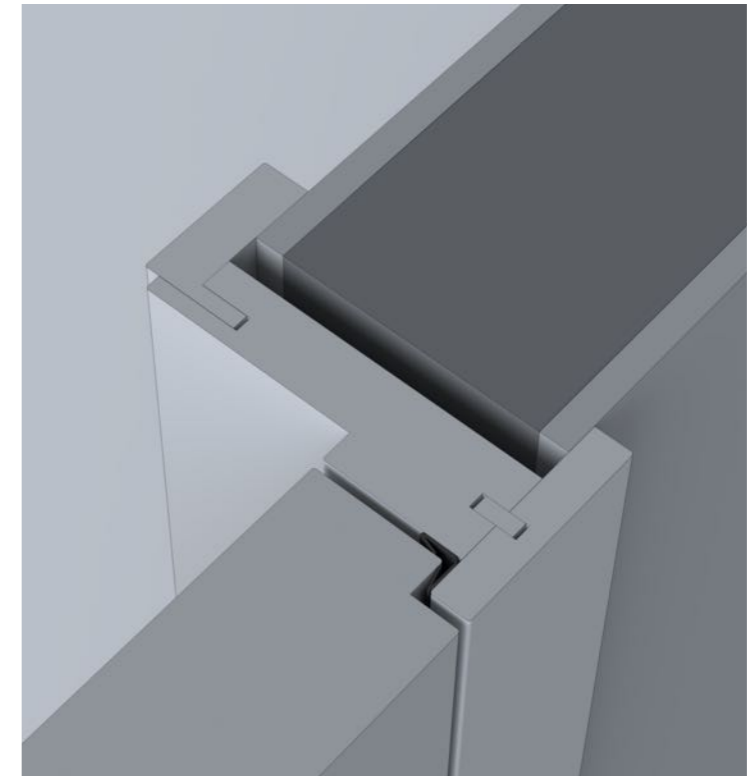

Section of a full casing-covered jamb on one side and an adjustable jamb on the other side, outside flush swing-in.



Section of a full casing-covered jamb on one side and an adjustable jamb on the other side, outside flush swing-out.

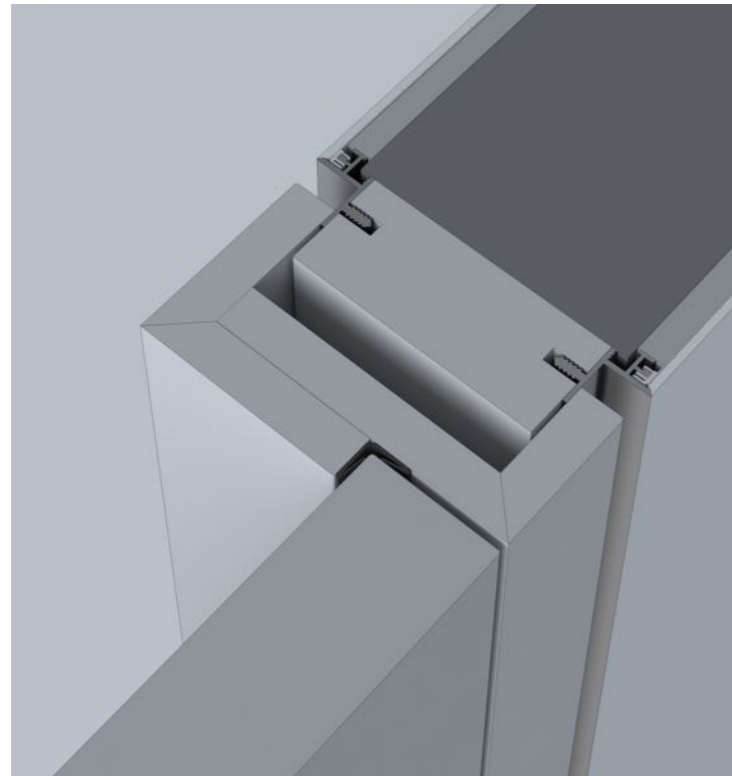

Section of a L shape door jamb with one side adjustable casing, installed on shadow gap subframe.





Elm Brushed

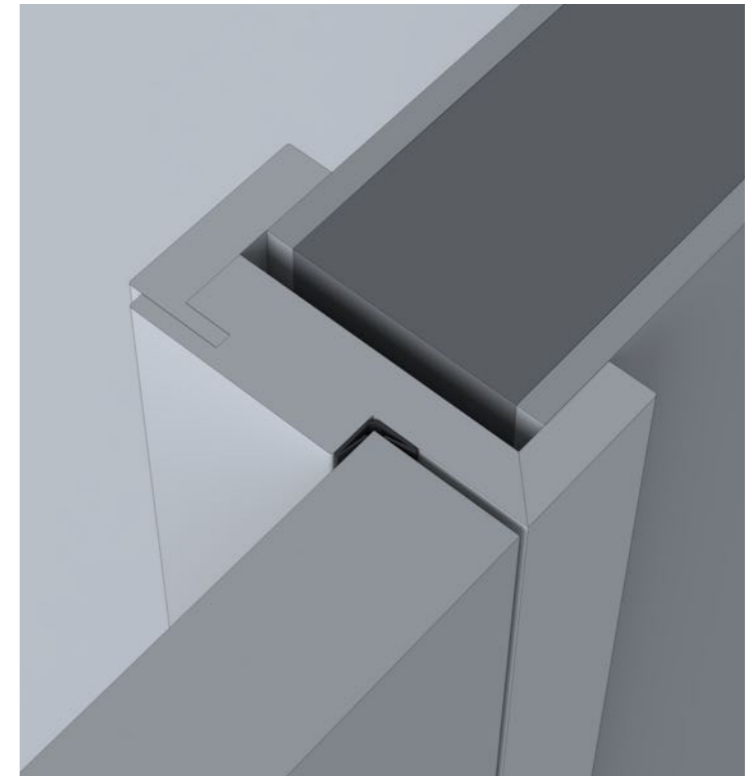

Section of a L shape door jamb with one side adjustable casing, installed on normal masonry or dry wall.



Black Walnut Natural







DESIGN OPTIONS

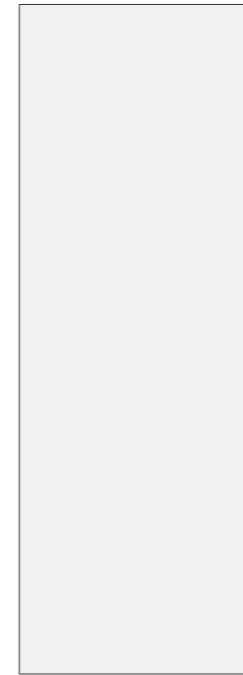

01

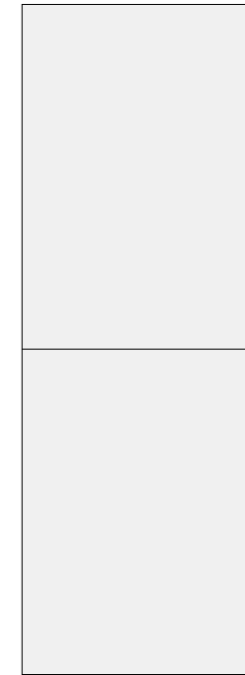

02



03

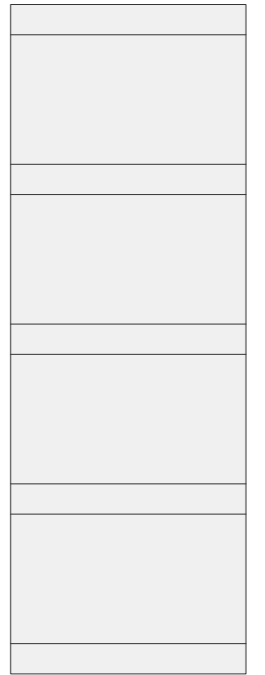

04



05

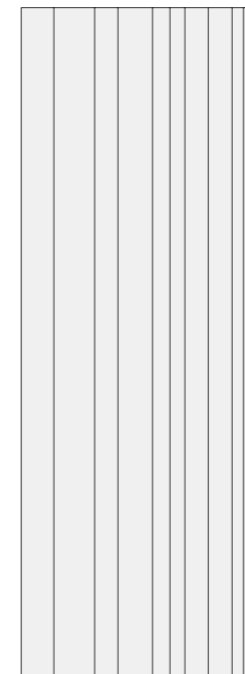

06

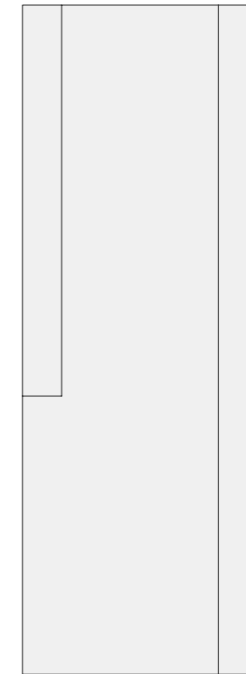

07

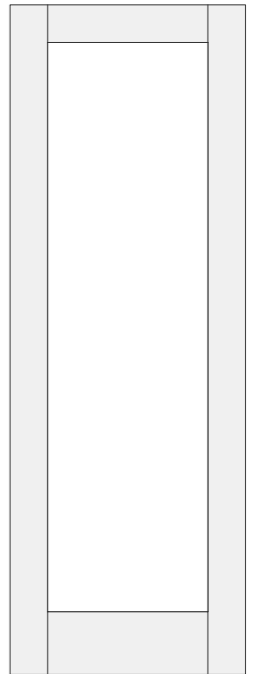

08

GRACE





DESIGN OPTIONS

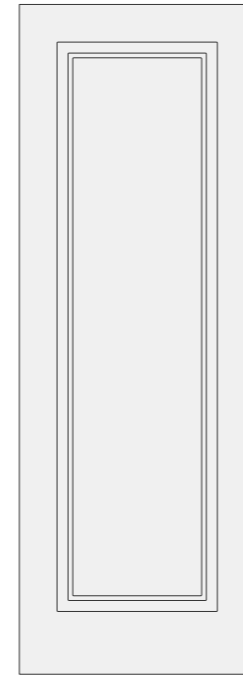

01

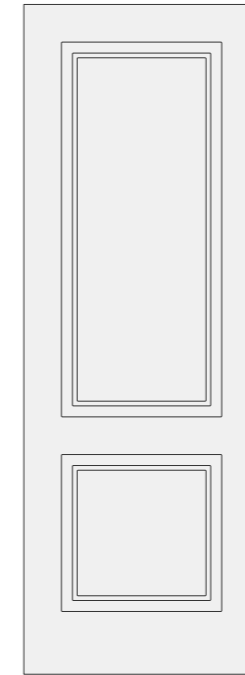

02

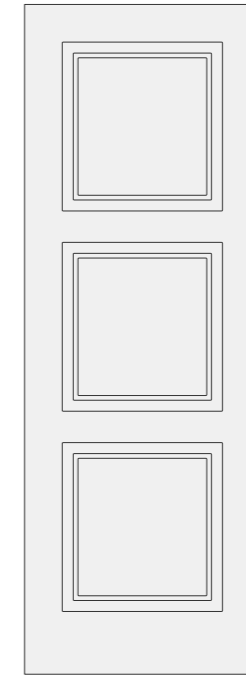

03

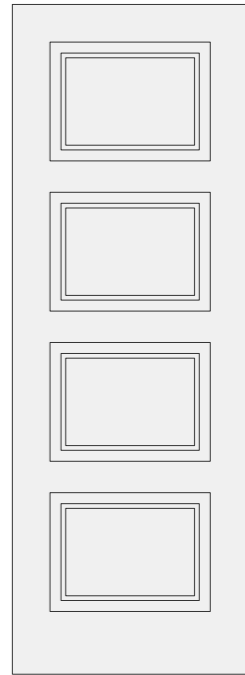

04

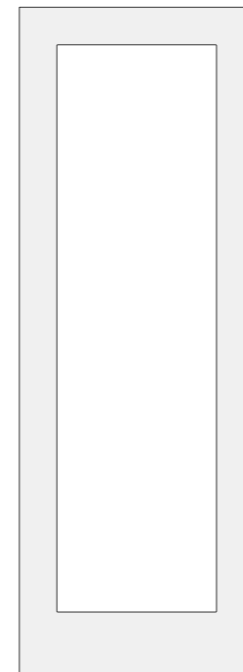

05

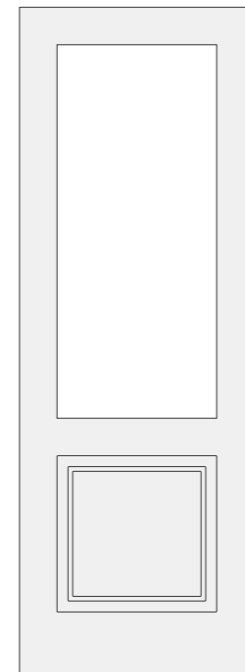

06

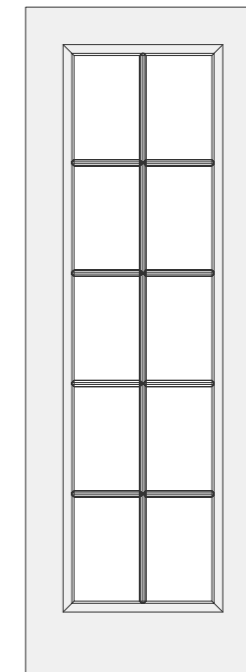

07

RHYME





DESIGN OPTIONS

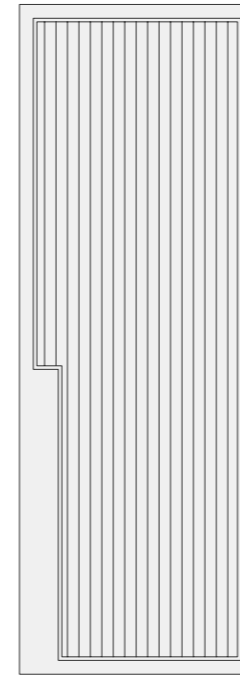

01

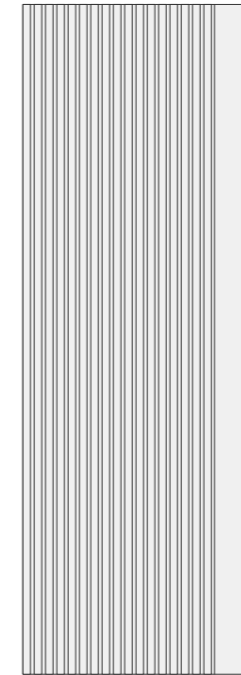

02

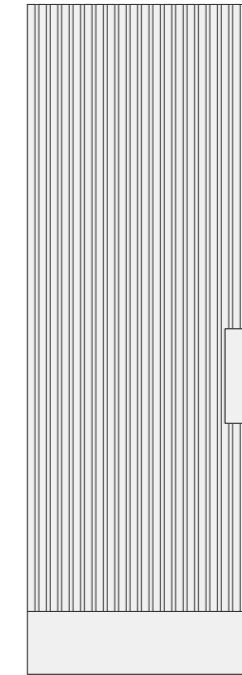

03

SHAKER



Walnut Oak





DESIGN OPTIONS

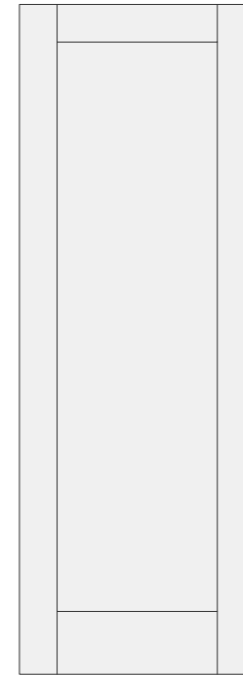

01

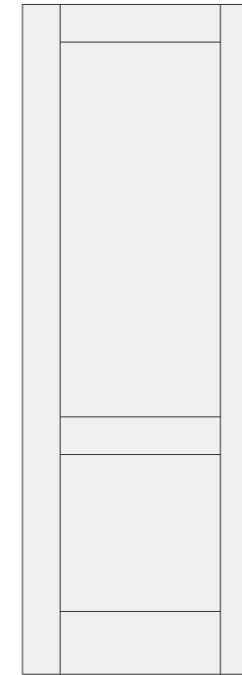

02

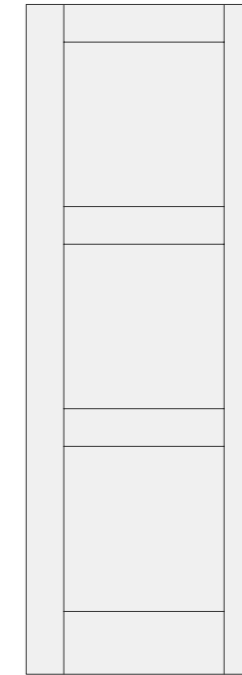

03

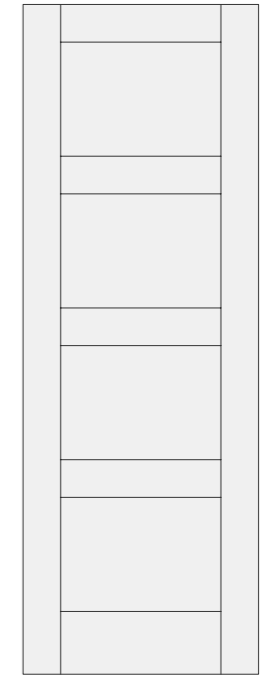

04

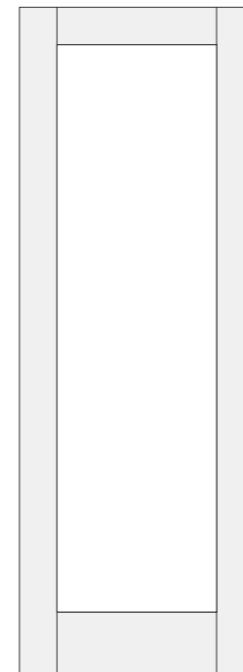

05

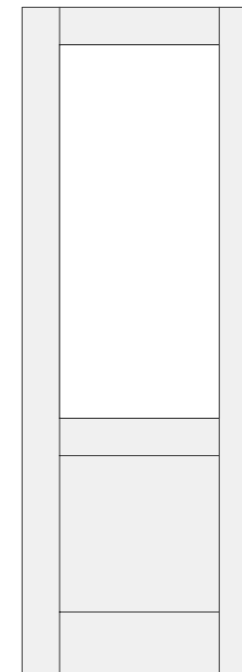

06

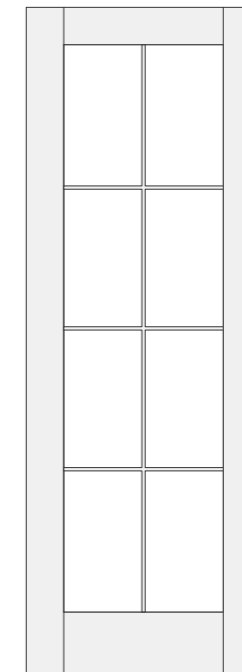

07

HARMONY





Light Clay Gray Oak

DESIGN OPTIONS

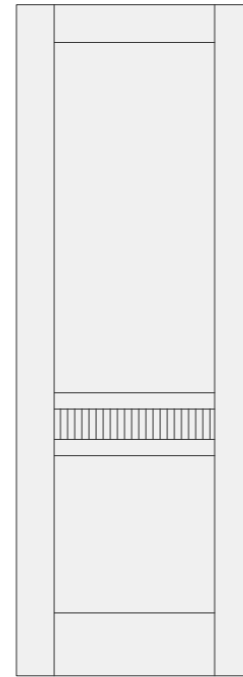

01

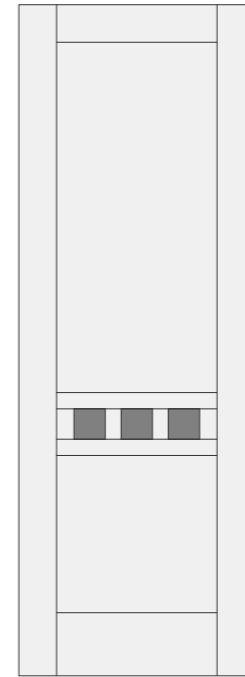

02

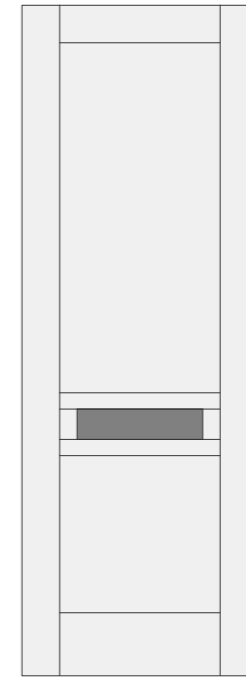

03

MAGIC DOOR





HARDWARE OPTIONS



BJ79231



BJ79247



BJ79270



BJ79222



BJ79206



BJ79207



BJ74205



BJ74268



BJ74225



Magnetic mortise lock



4.5\"X4.5\" SS Hinge



4\"X3\" SS Hinge



Zinc Alloyed Hidden hinge

HARDWARE COLOUR OPTIONS



PC Polished Chrome



MSN Matt Satin Nickel



BLK Matt Black

STANDARD VENEER STAINED COLOURS



Ice oak

Light ice oak

Clay gray oak

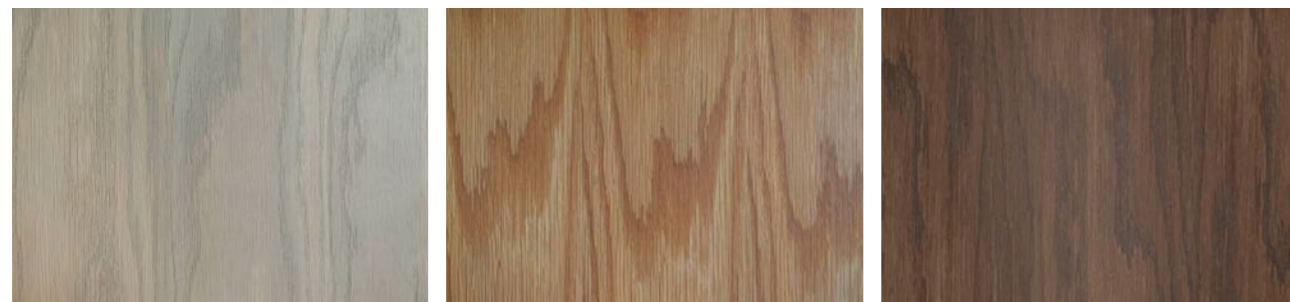

Light clay gray oak

Natural oak

Walnut oak



Teak oak

Black oak

Wenge oak

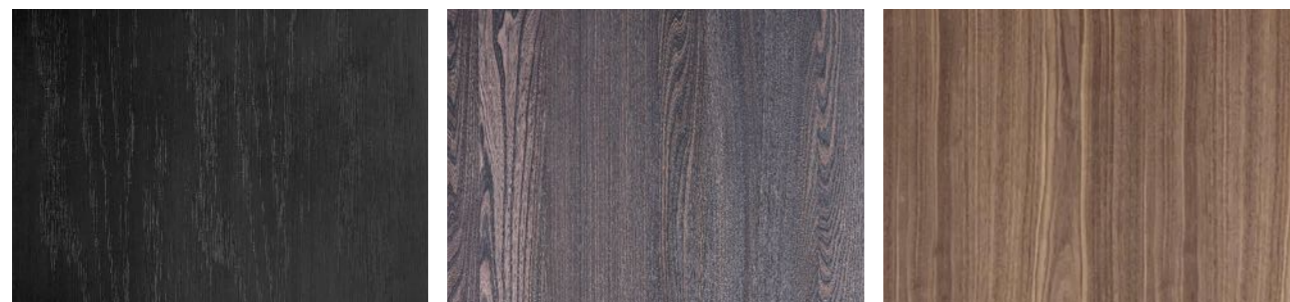

Dark wenge oak

Brushed Elm

Natural Black Walnut

STANDARD MATT AND GLOSSY PAINT

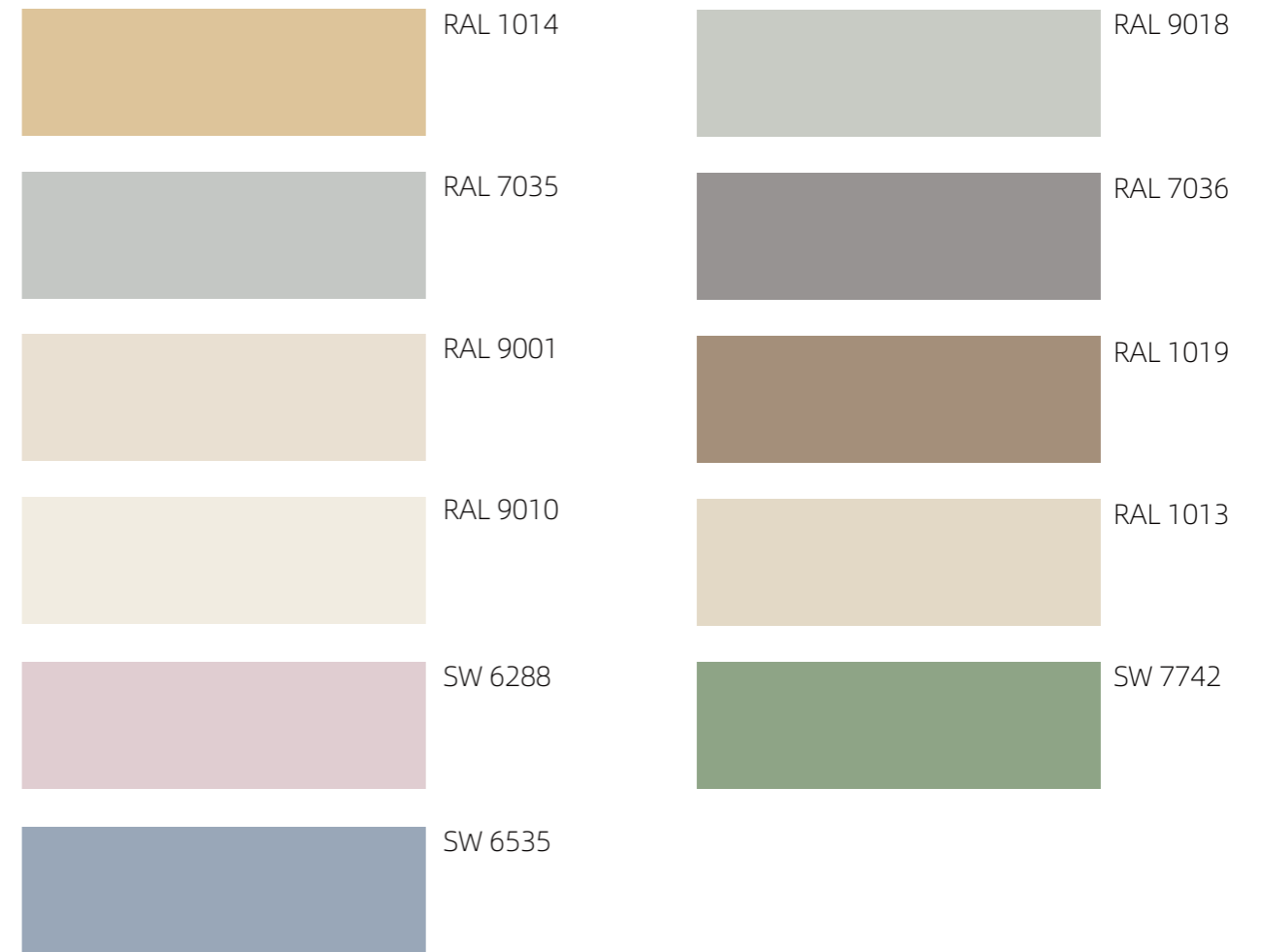

STANDARD OPEN GRAIN LAQUERED COLOURS

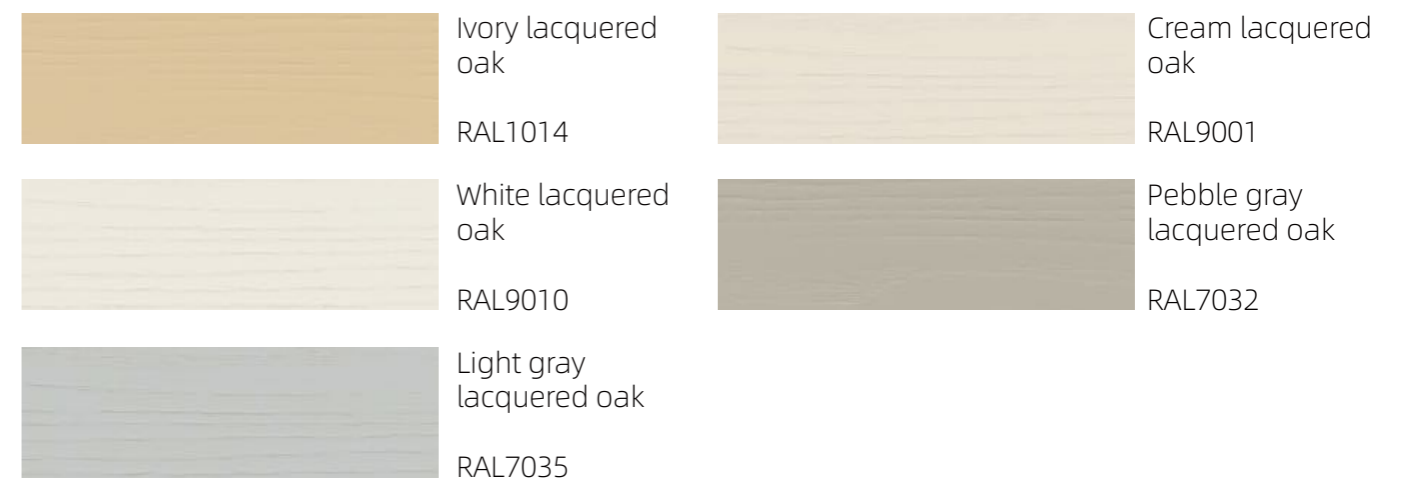

TECHNICAL DRAWINGS

Pull Opening

Adjustable jamb with one-side casing
flush with door

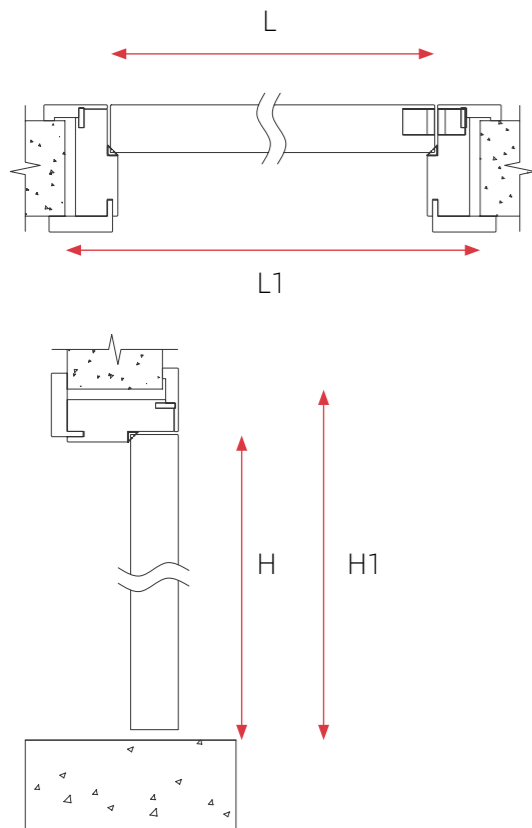

L - finished opening width
600-900mm. 24" -36"
H - finished opening height
Max 3000mm, 118 - 1/4"
L1 - rough opening width
L + 90mm
H1 - rough opening height
H + 55mm

Push Opening

Adjustable jamb with one-side casing
flush with door

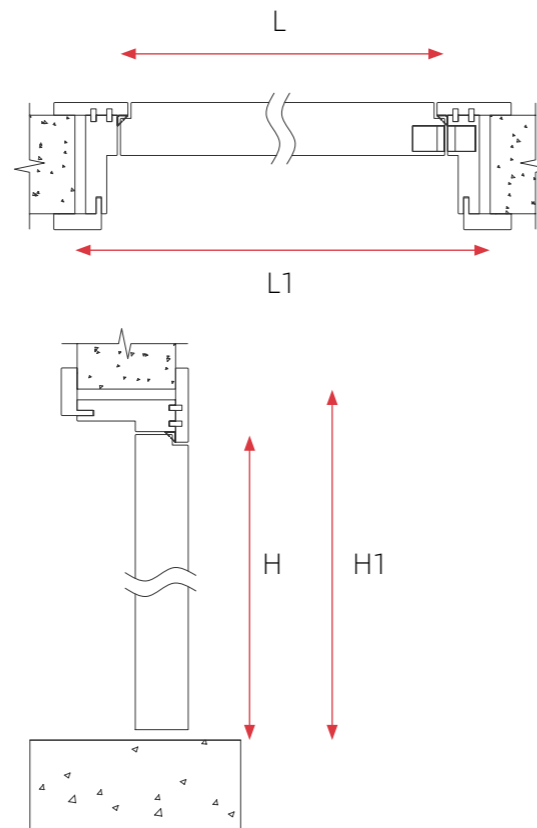

L - finished opening width
600-900mm. 24" -36"
H - finished opening height
Max 3000mm, 118 - 1/4"
L1 - rough opening width
L + 110mm
H1 - rough opening height
H + 65mm

TECHNICAL DRAWINGS

Magic door

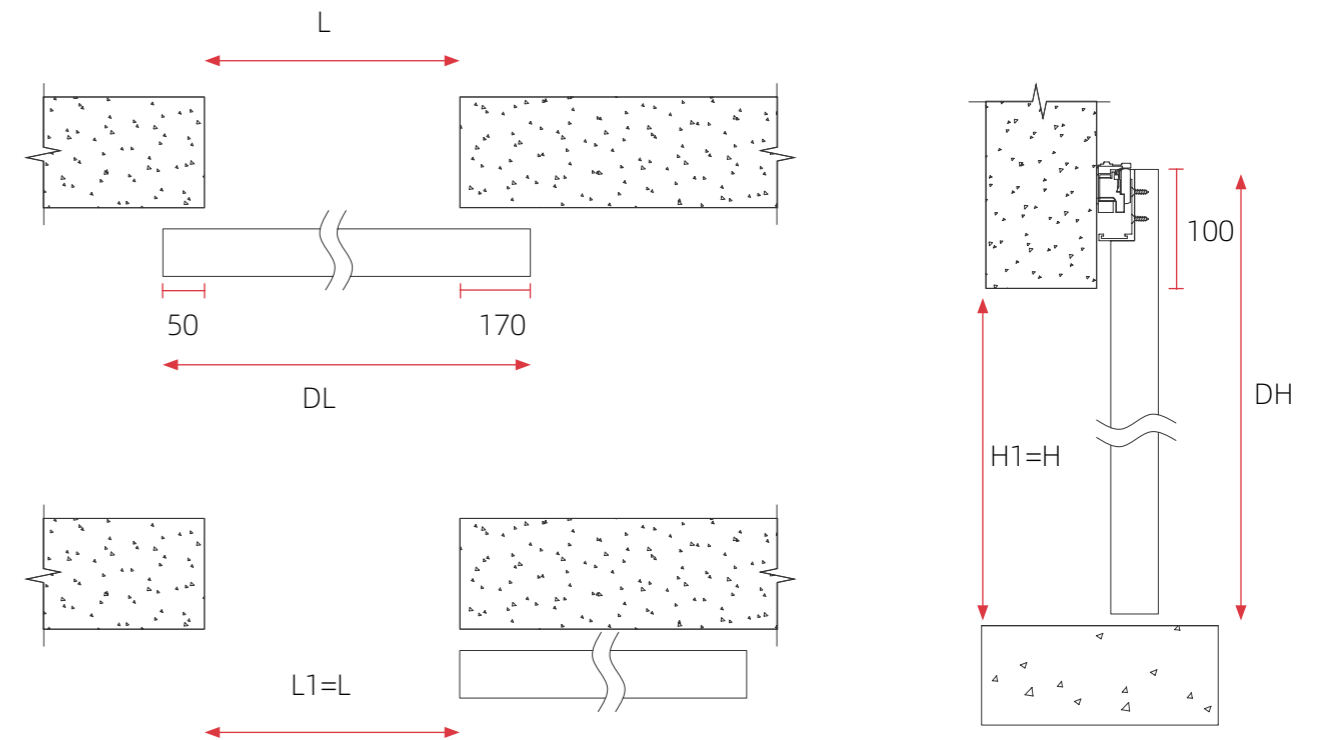

L - opening width
600-900 27 1/2" - 35 1/2"
H - opening height
Max 3000mm, 118
DL - door width
L + 220mm